

Das Versteck 1:

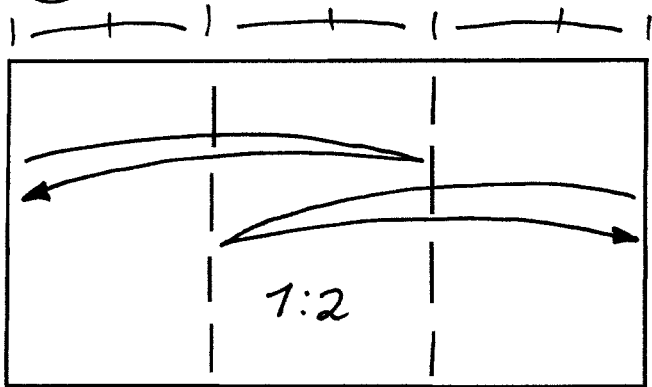

1

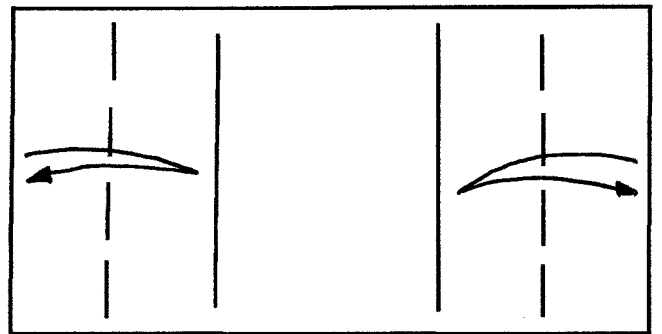

2

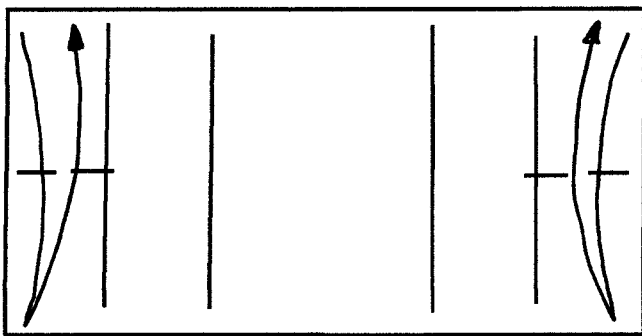

3

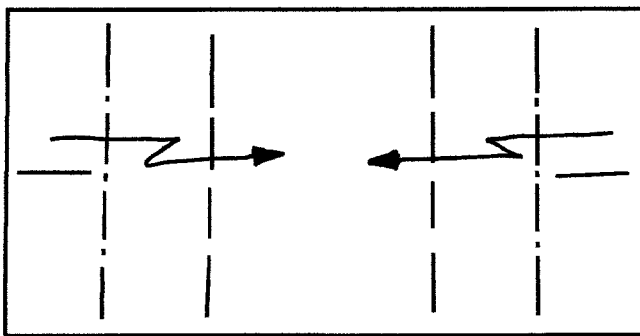

4

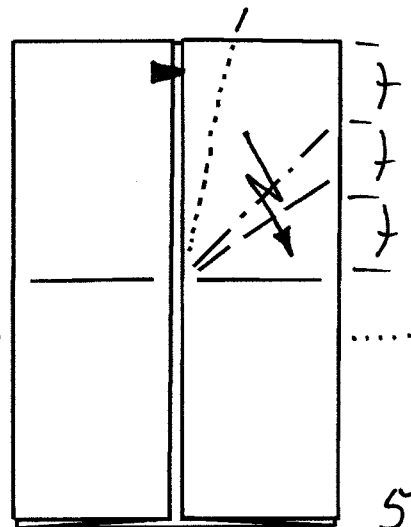

5

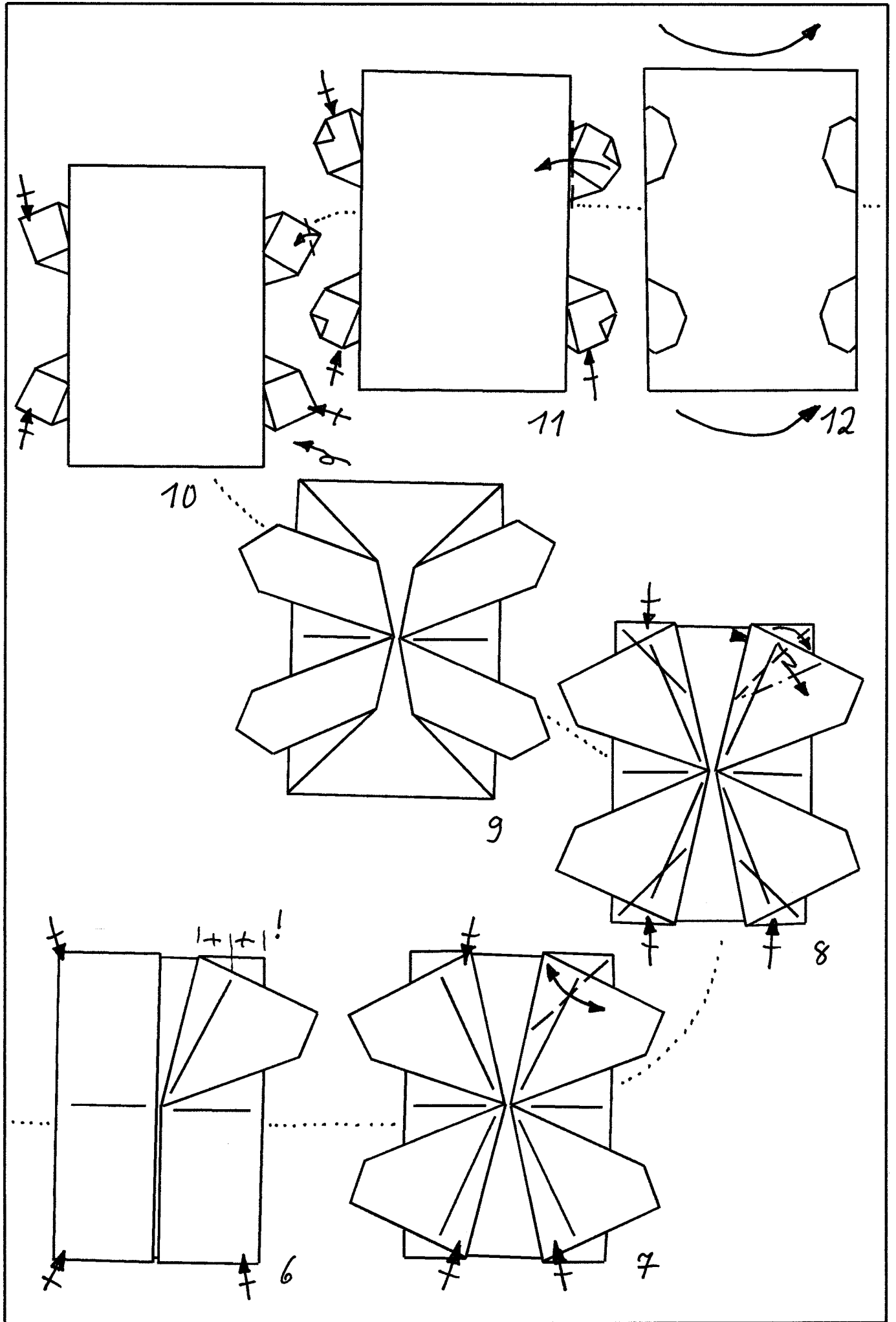

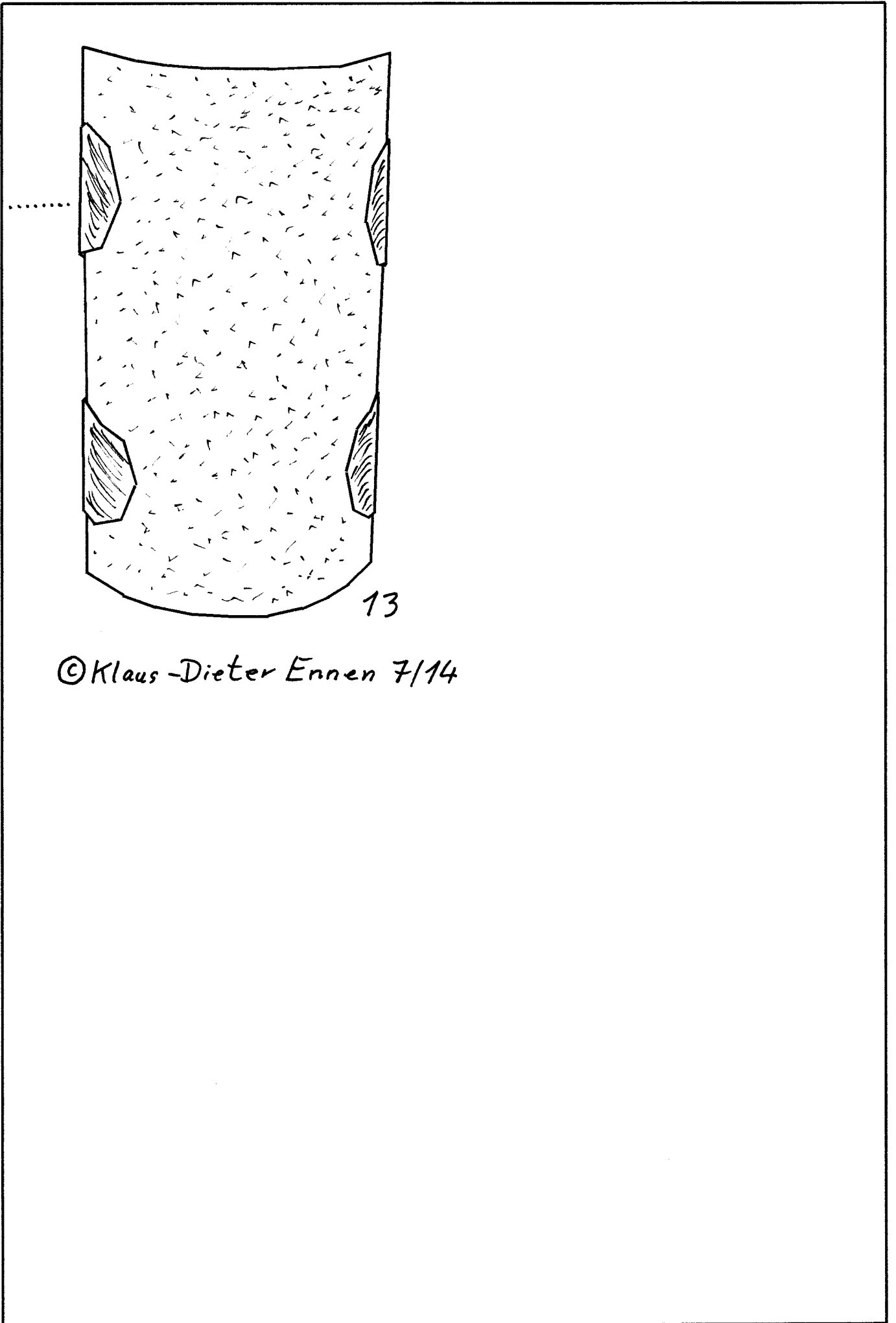

©Klaus-Dieter Ennen 7/14