

H=Deckel:

Farbe unten

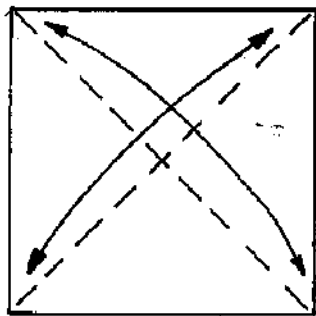

1

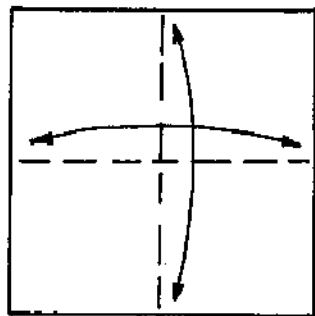

2

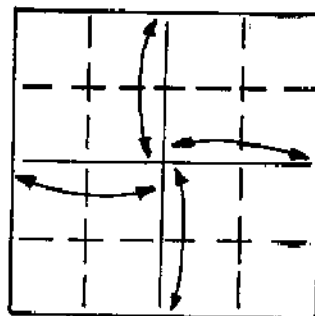

3

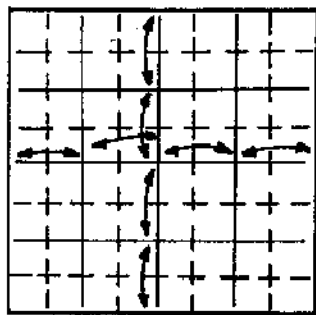

4

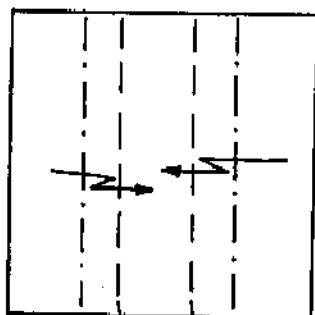

5

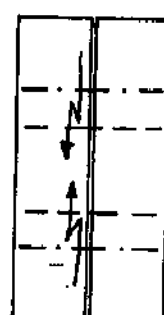

6

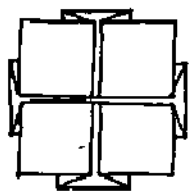

7

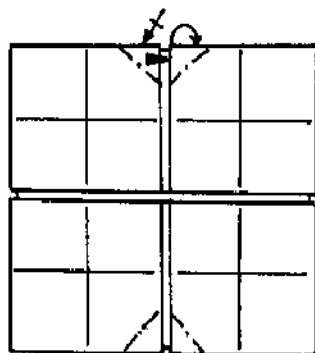

8

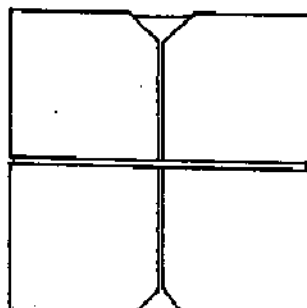

9

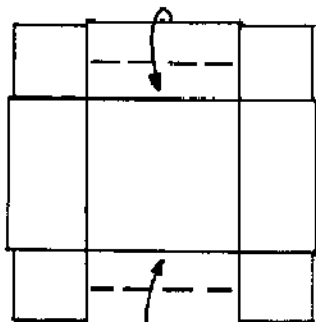

10

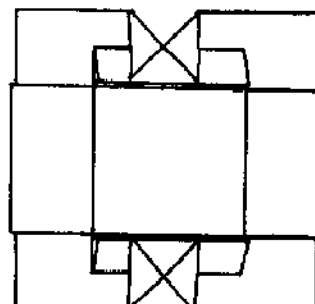

11

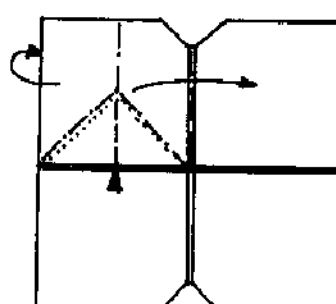

12

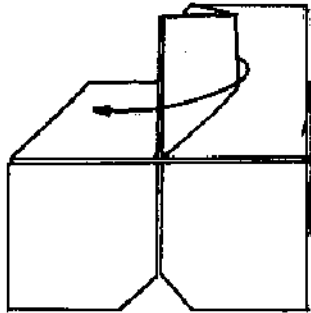

13

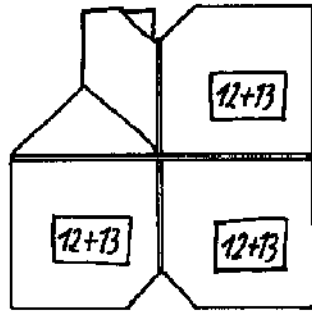

14

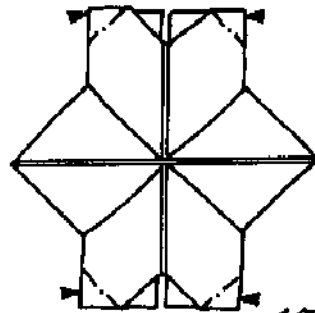

15

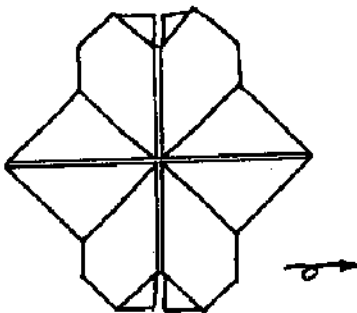

16

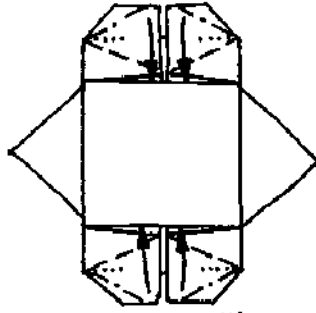

17

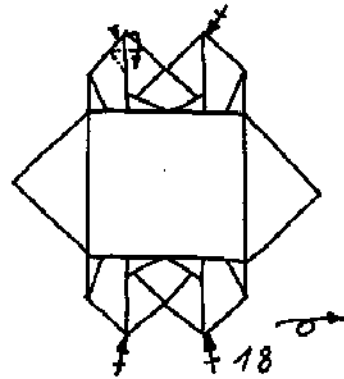

18

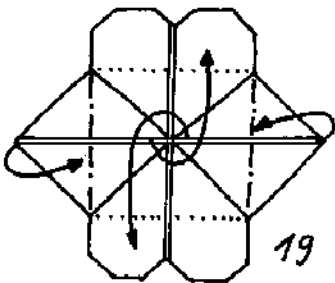

19

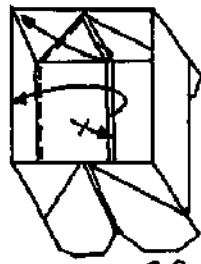

20

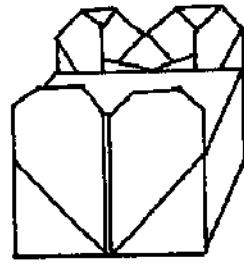

21

B = Box:

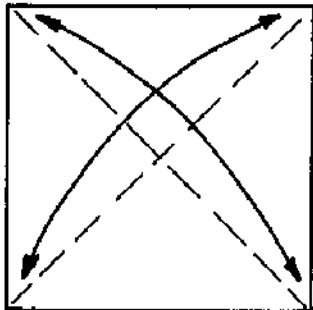

22

Farbe unten

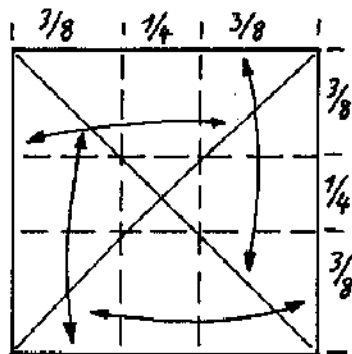

23

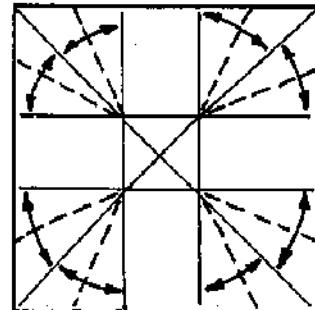

24

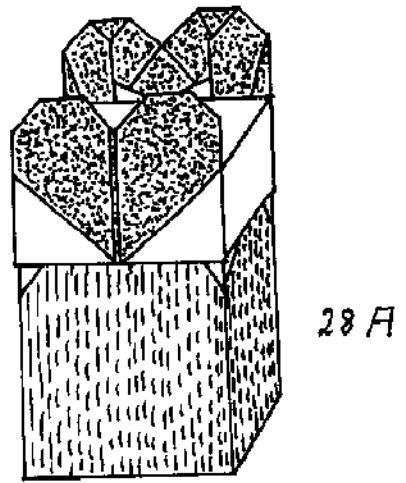
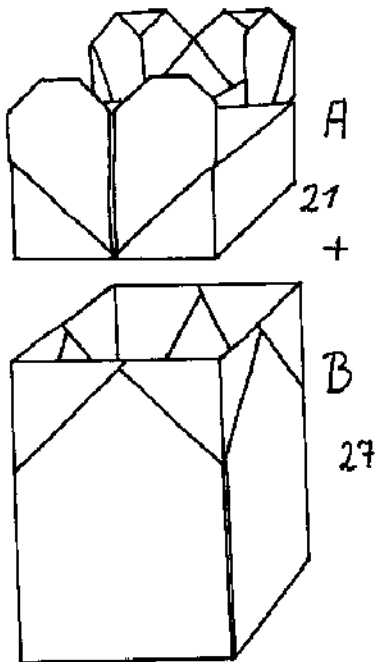
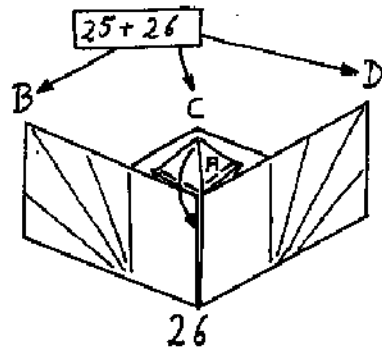
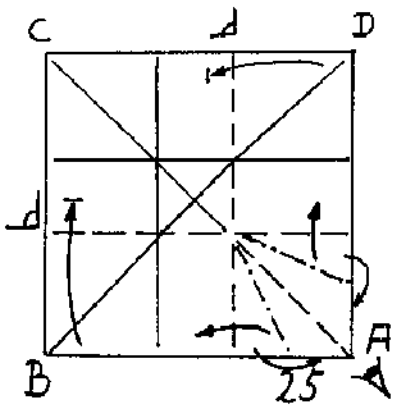

C=Box:

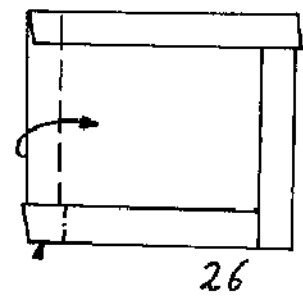
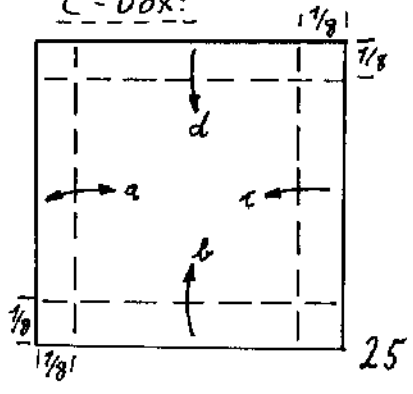

26

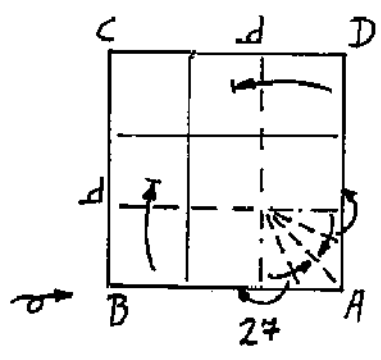

27

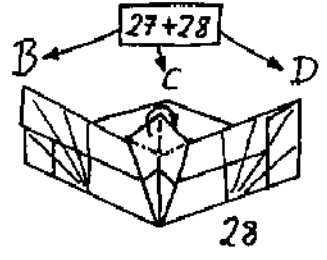

28



29

