

Schachtel 95:

Deckel:  $\begin{matrix} 15 \\ 4 \times 15 \end{matrix}$   $\begin{matrix} 1 \times \\ \text{Din-A5} \end{matrix}$  Boden:

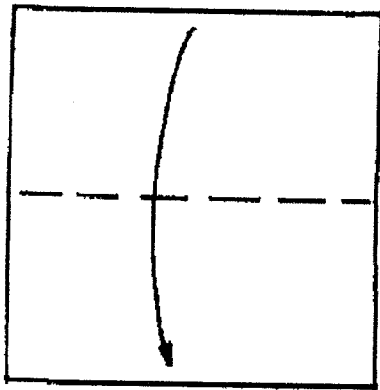

Deckel: 1

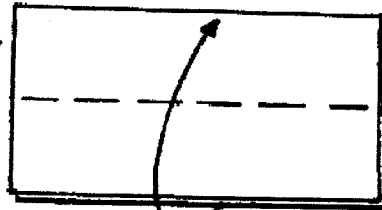

2



3



4

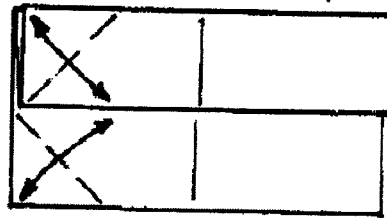

5

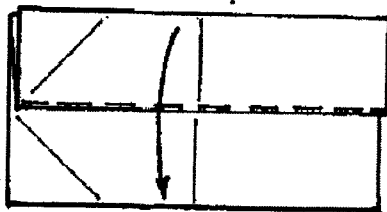

6

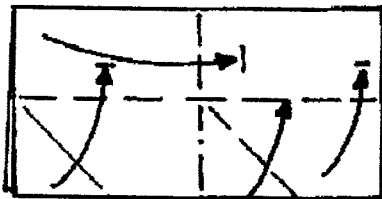

7

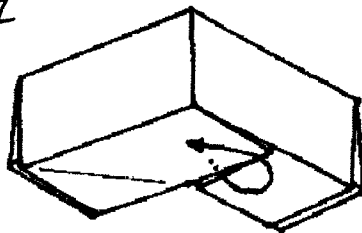

8

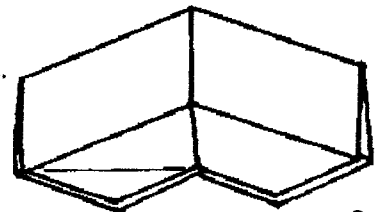

9

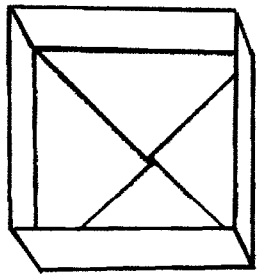

15

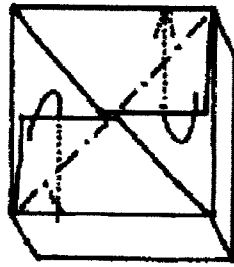

16

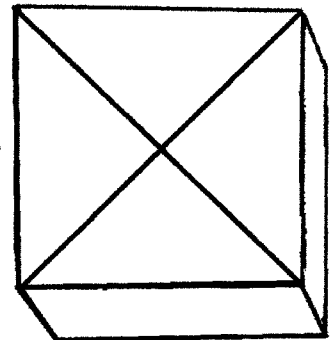

Decked:

17

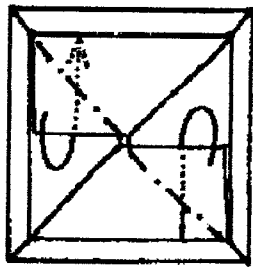

14

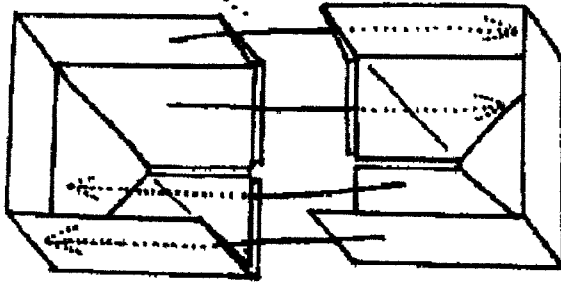

13



2x

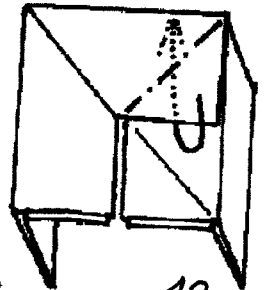

12

2x

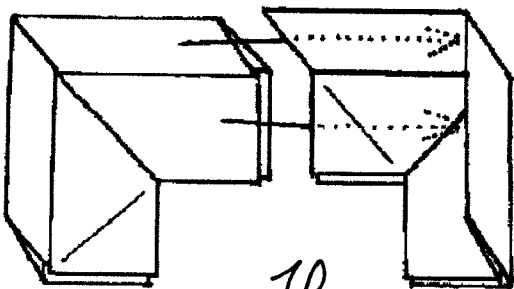

10

2x

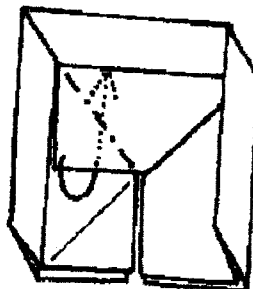

11



Din-A5

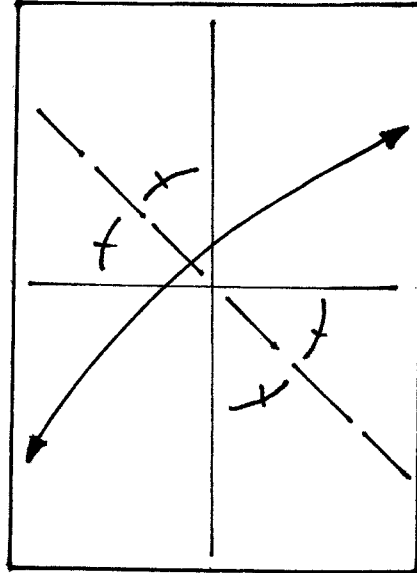
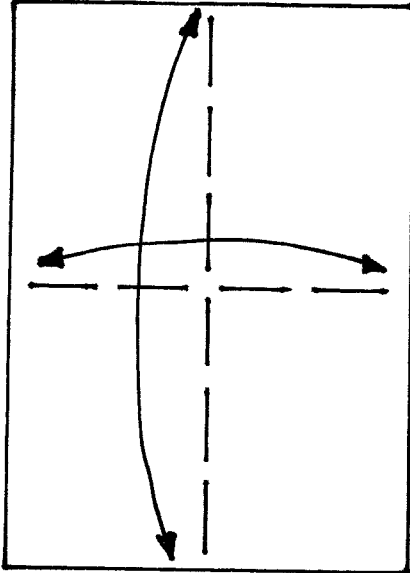

Boden:

18

19

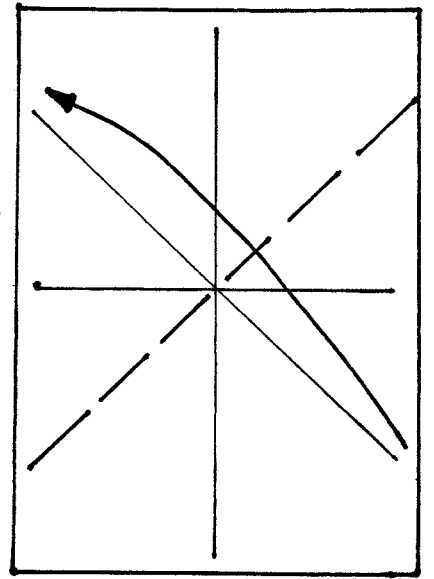
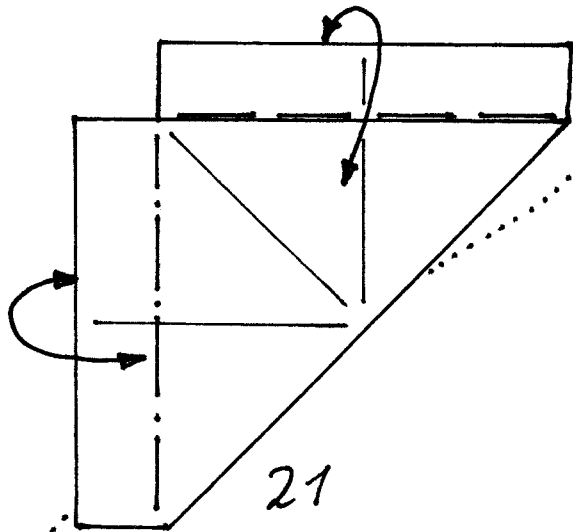

21

20

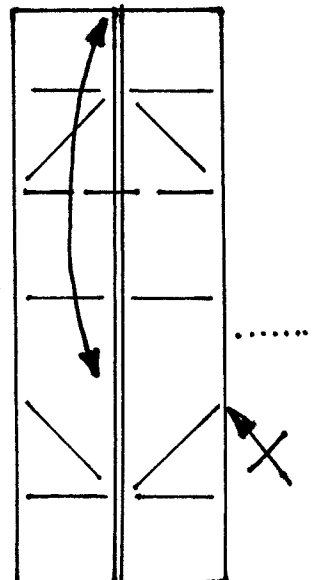
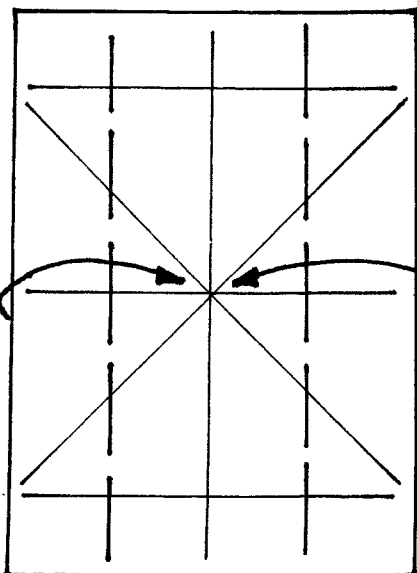
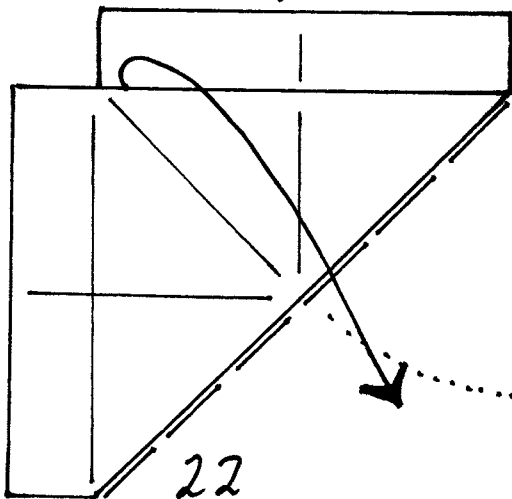

22

23

24

© Klaus-Dieter Ennen  
10114

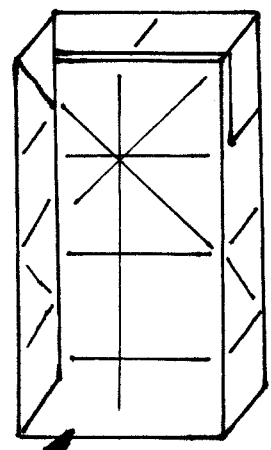
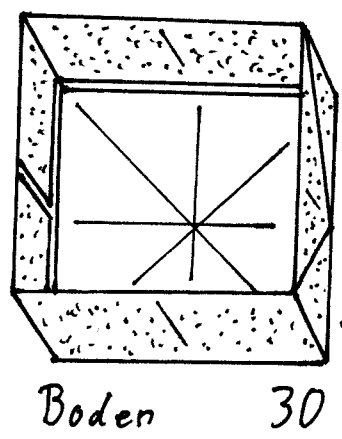
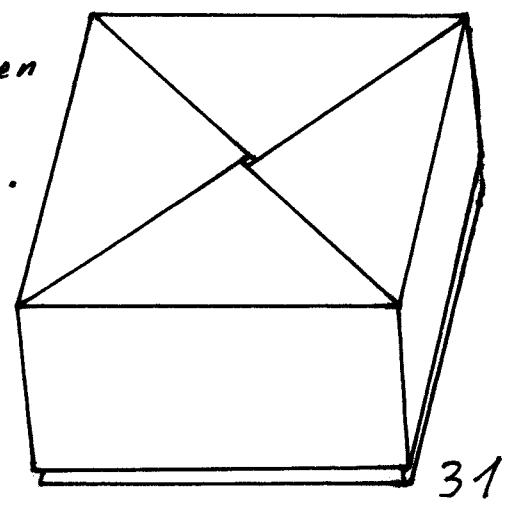

26-28

