

Der Stern, der ein Quadrat verschwinden läßt:

von Klaus-Dieter Ennen

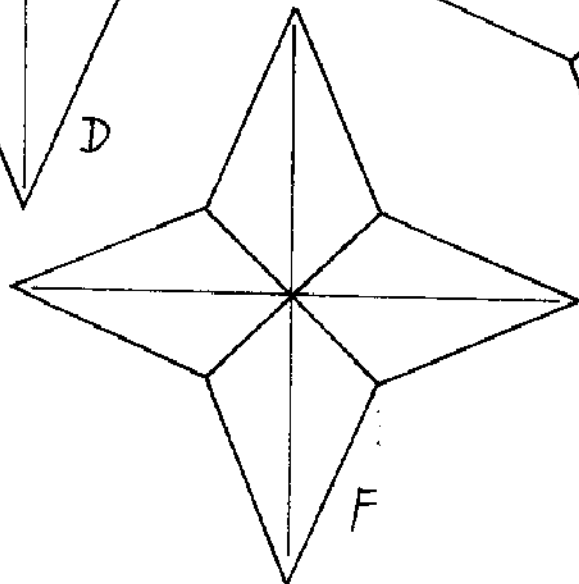
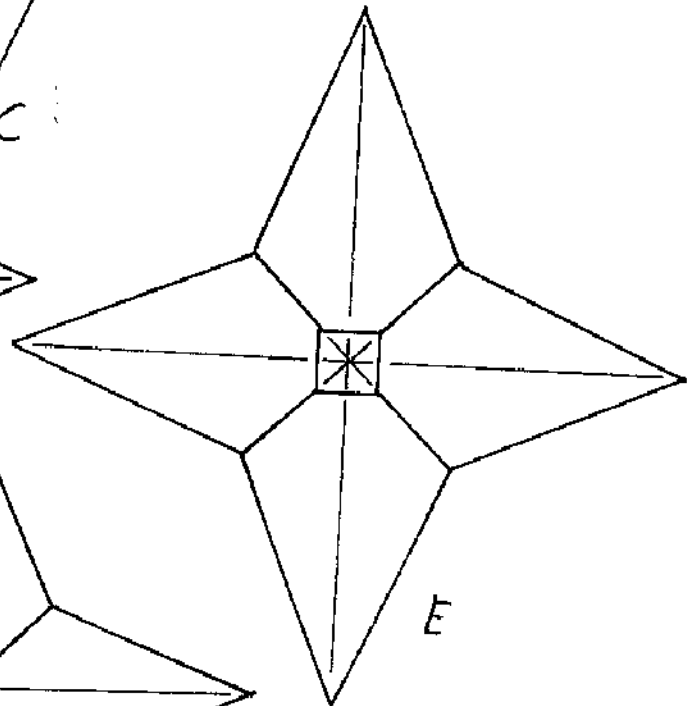
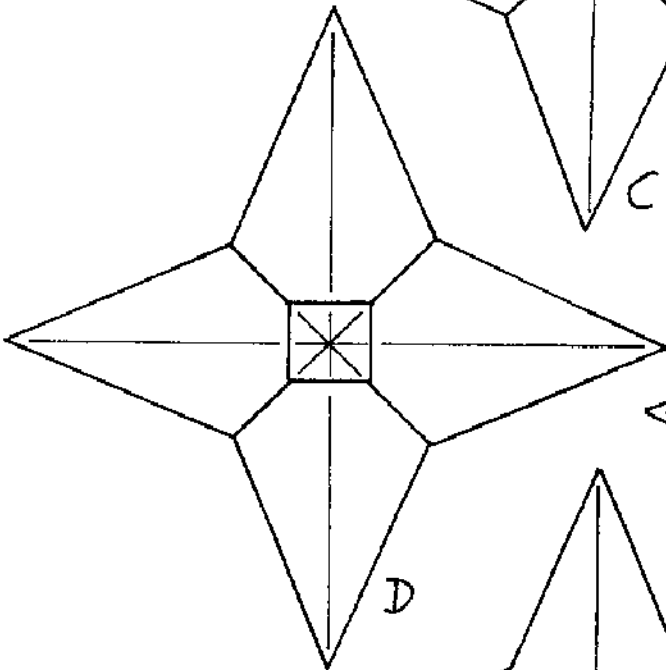
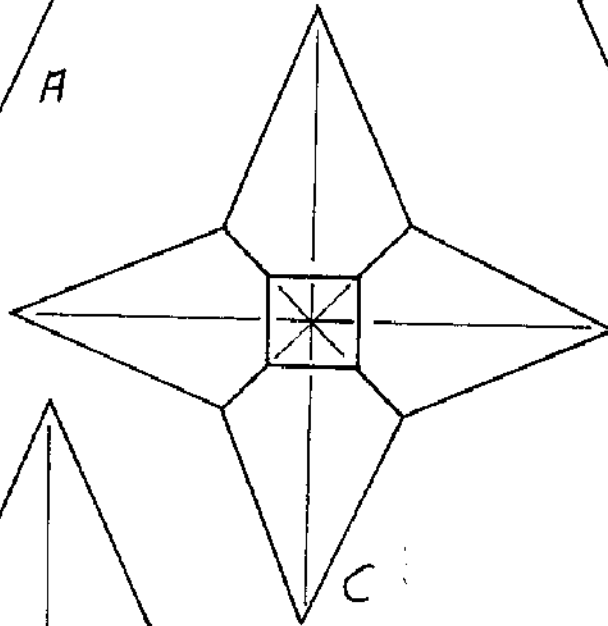
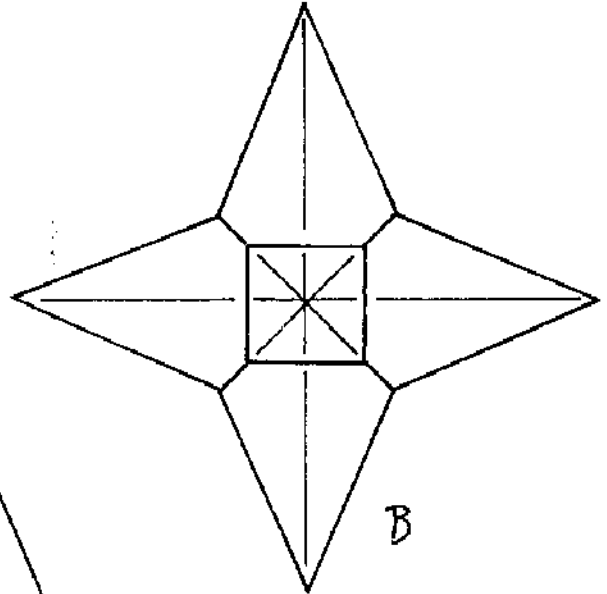
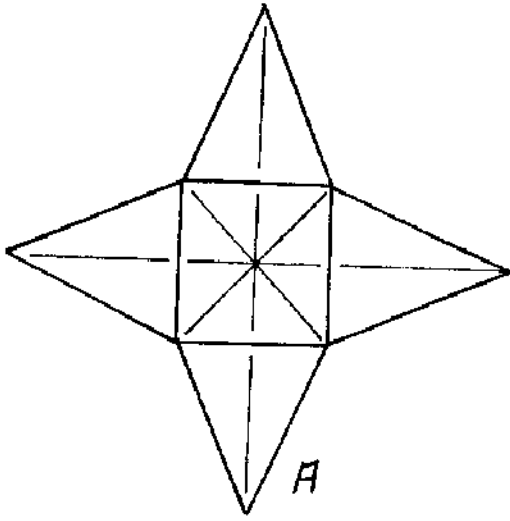

Stern A:

Farbe innen

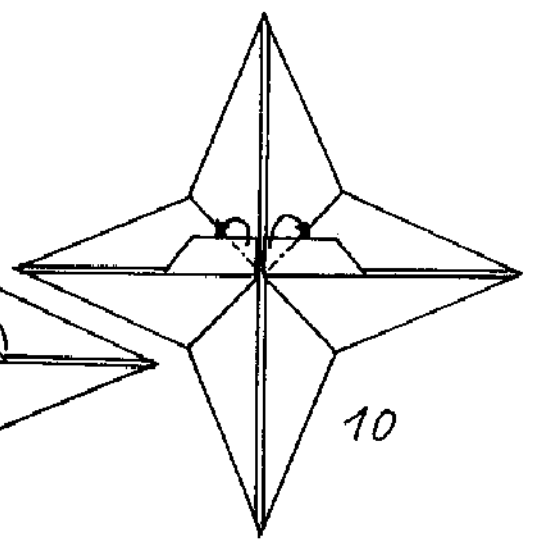
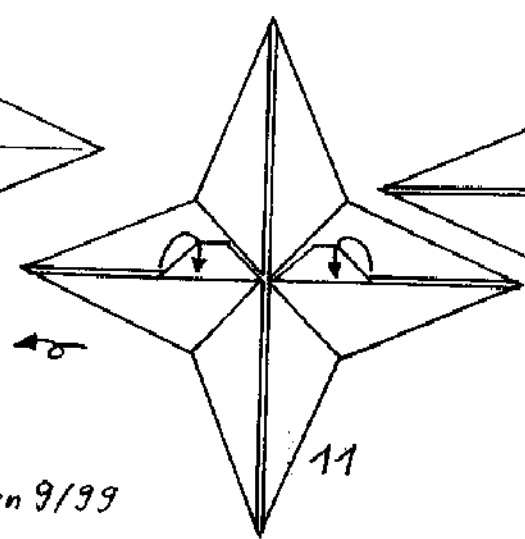
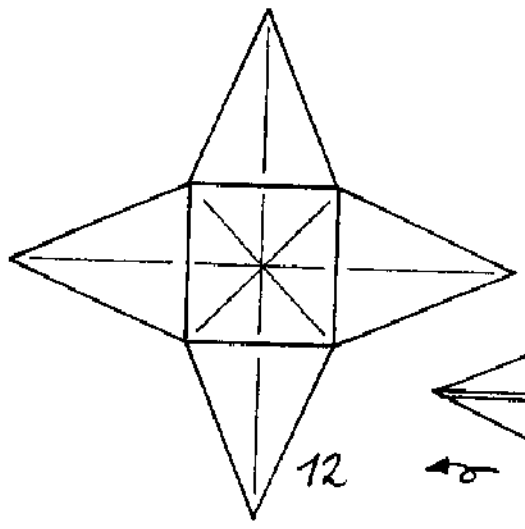
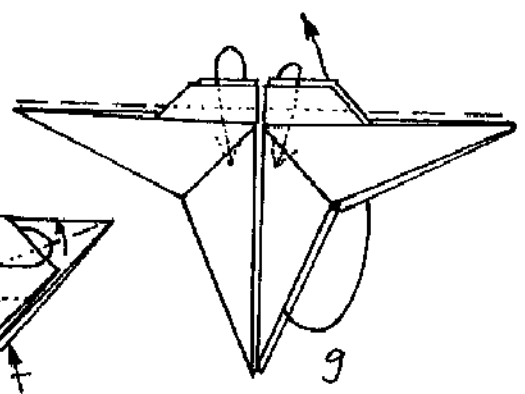
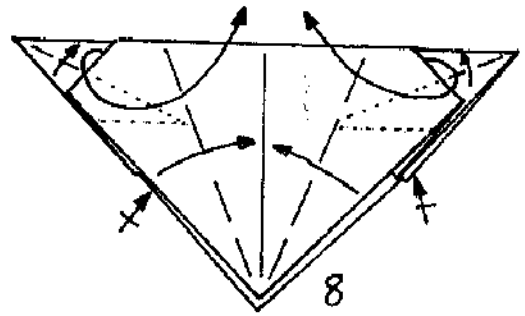
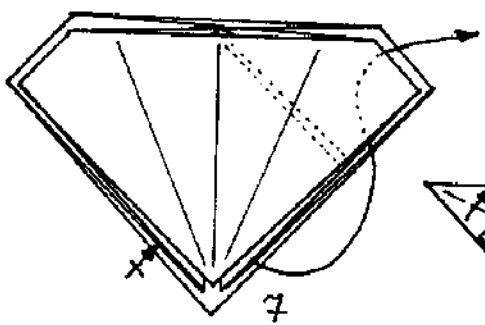
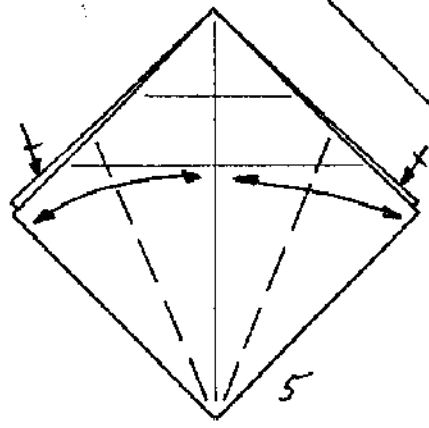
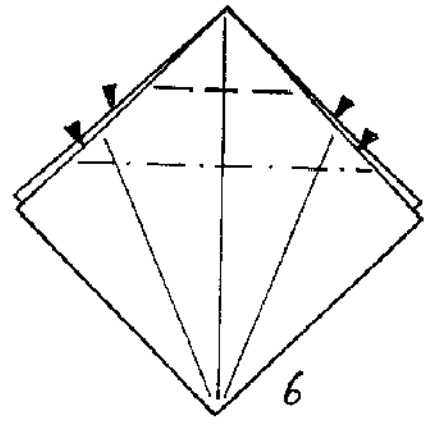
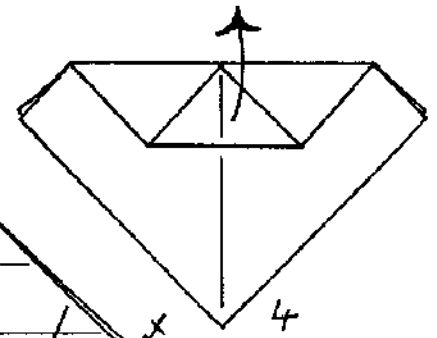
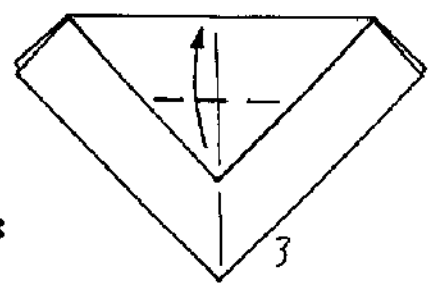
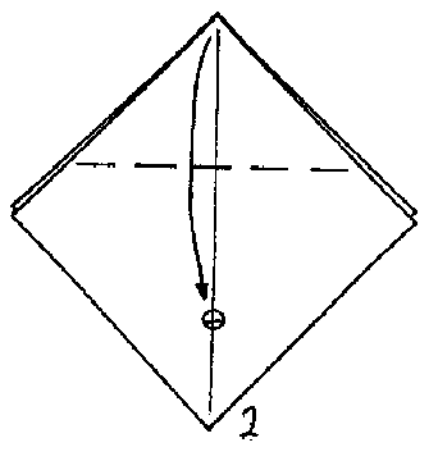
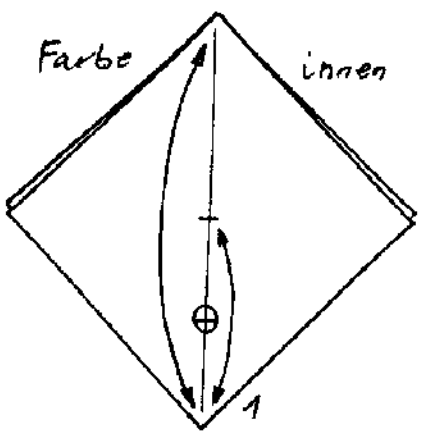

Stern B:

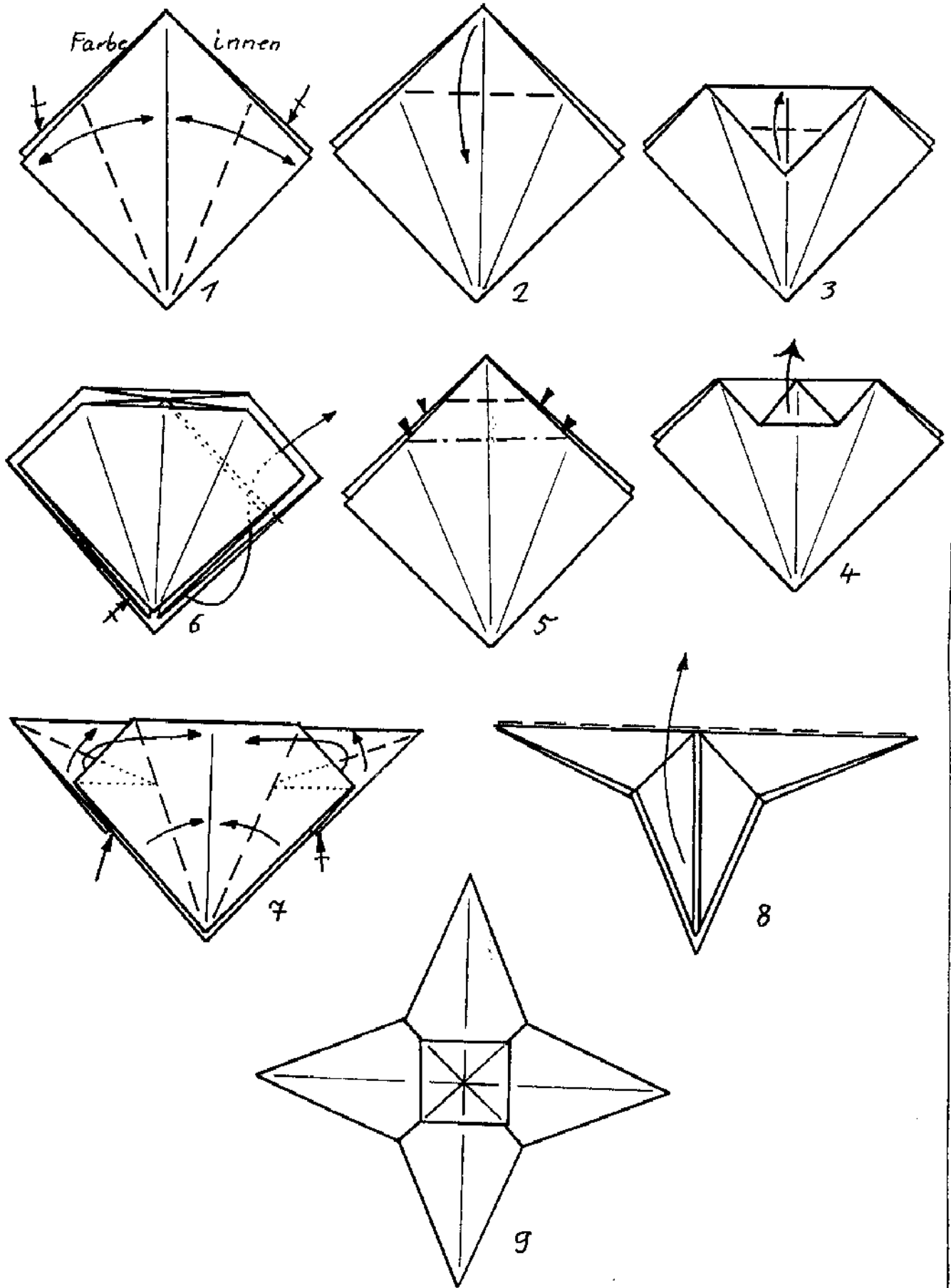

Stern C:

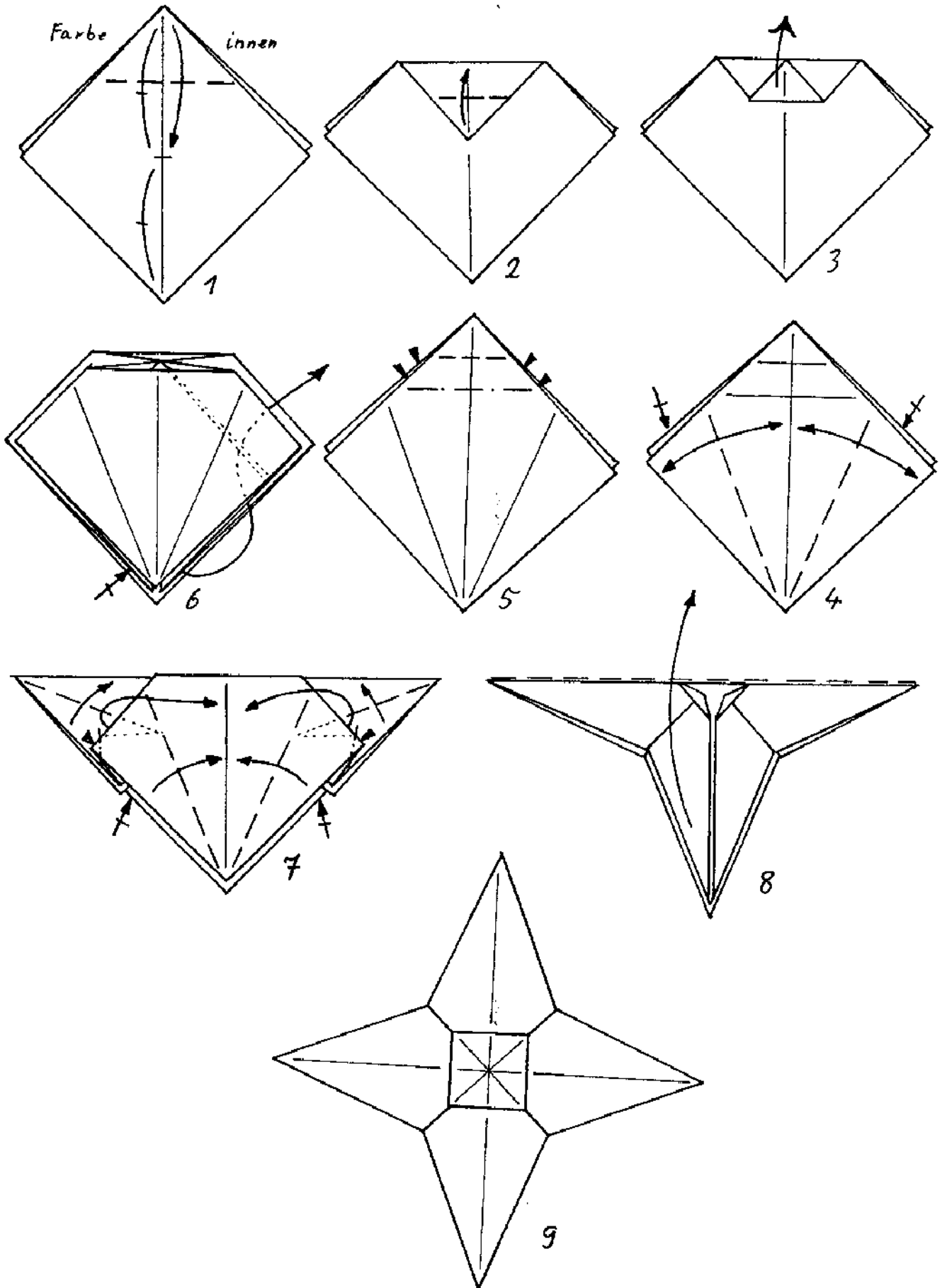

Stern D:

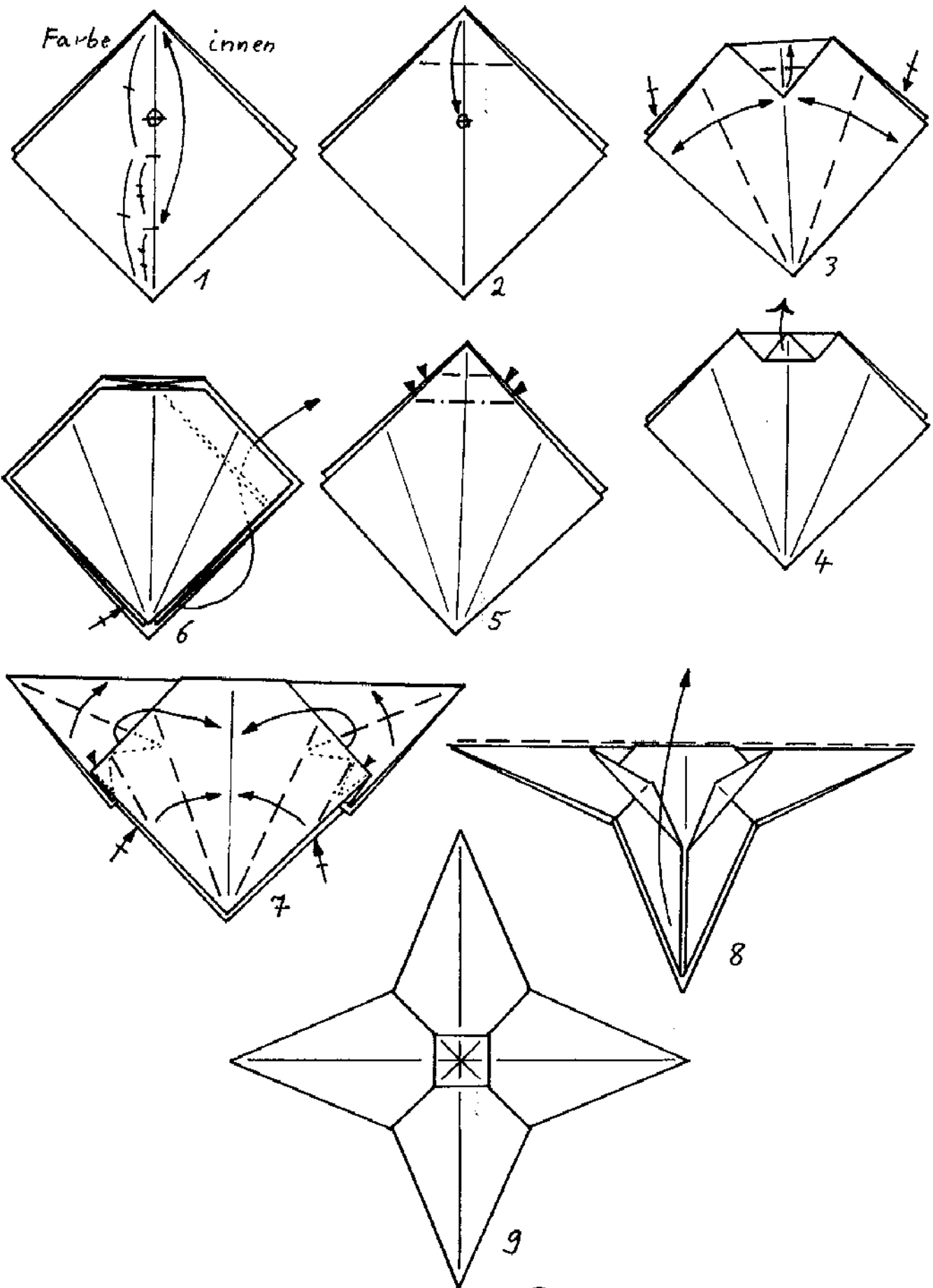

Stern E:

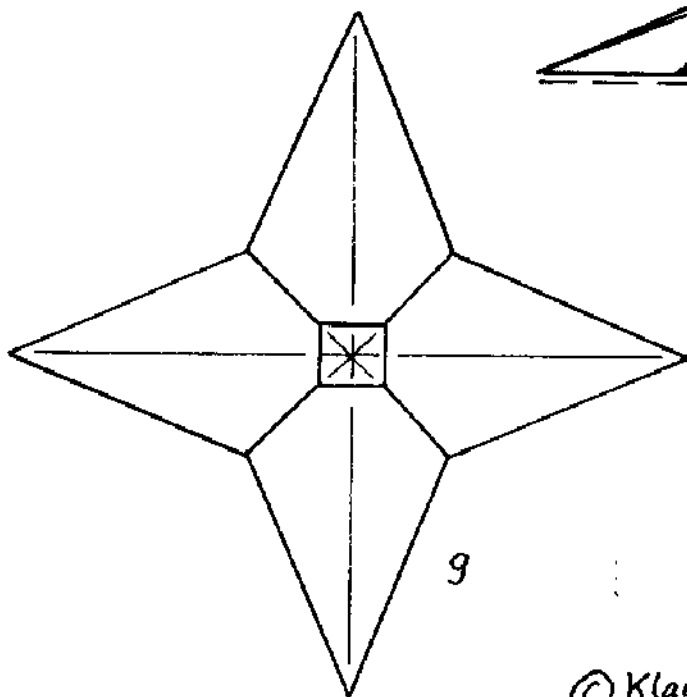
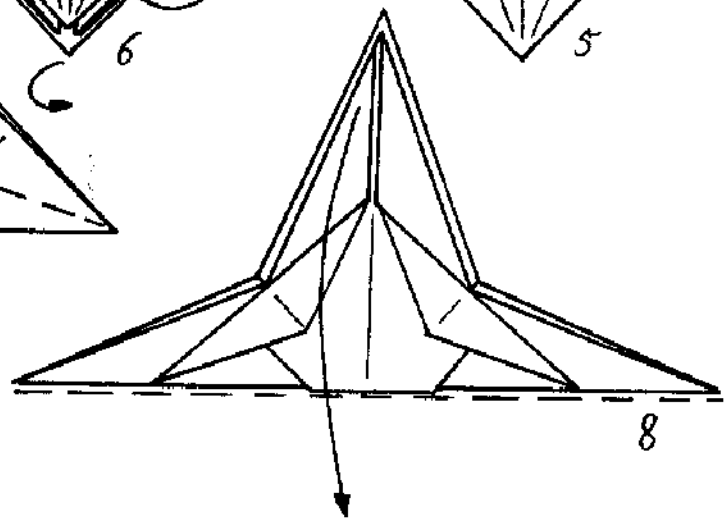
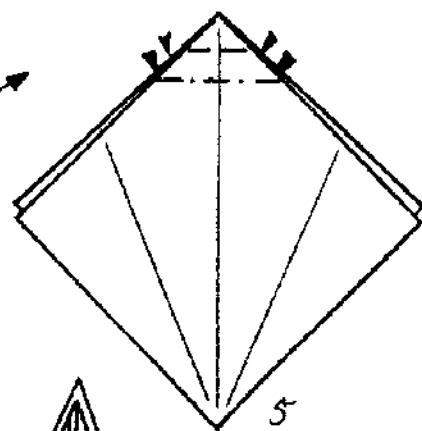
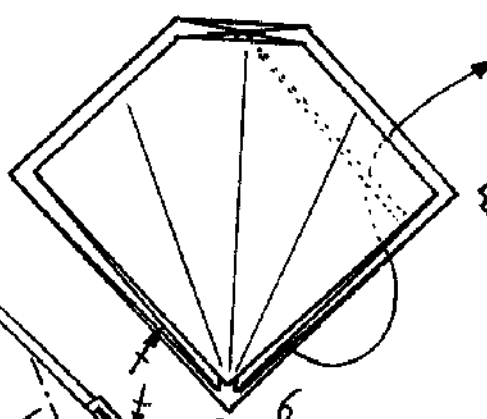
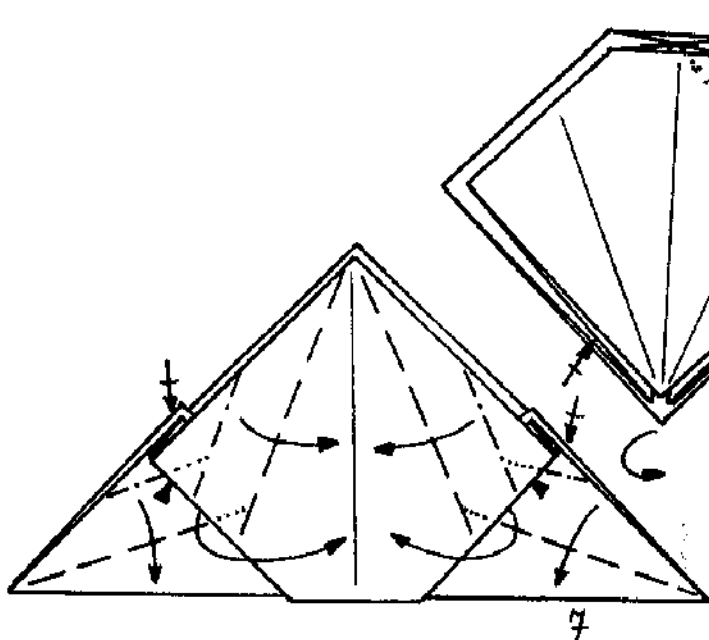
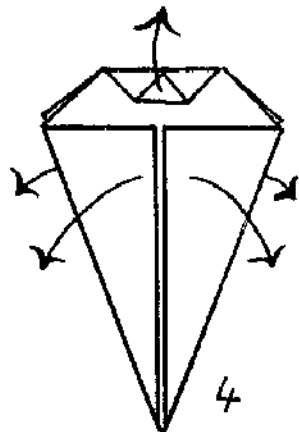
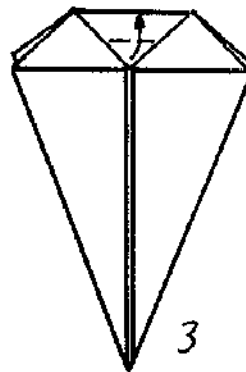
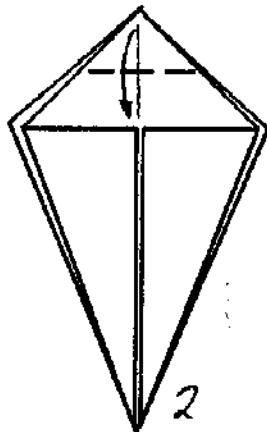
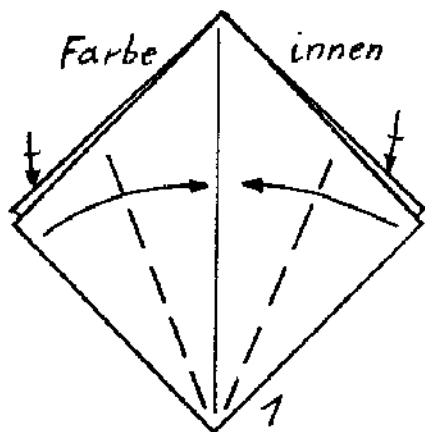

Stern F:

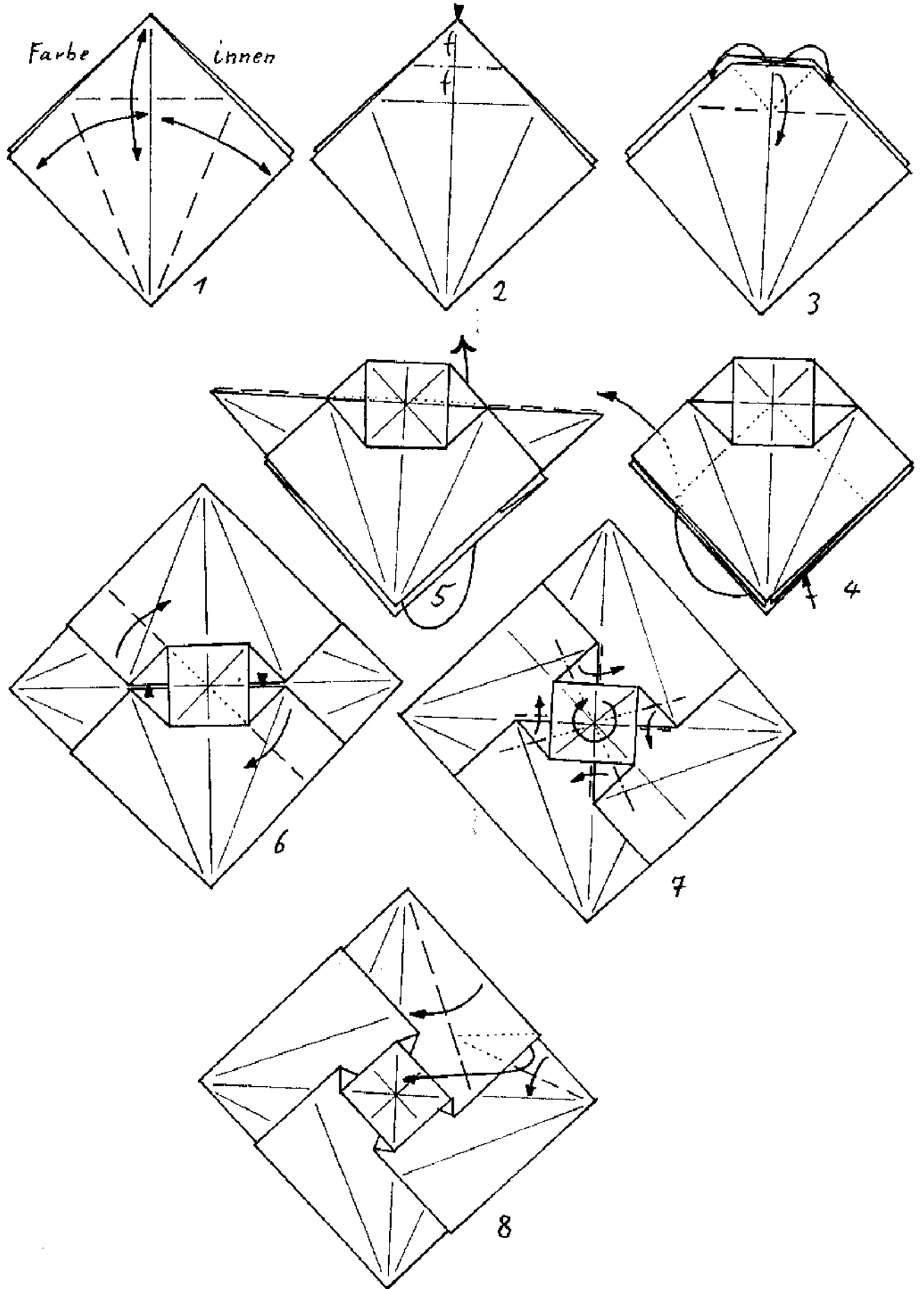

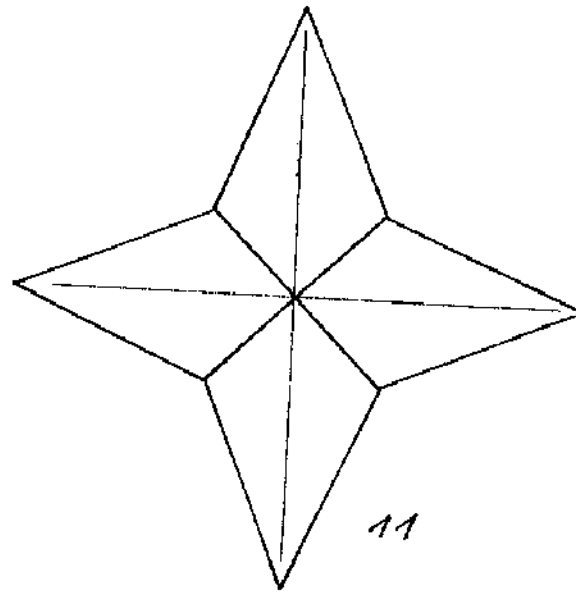
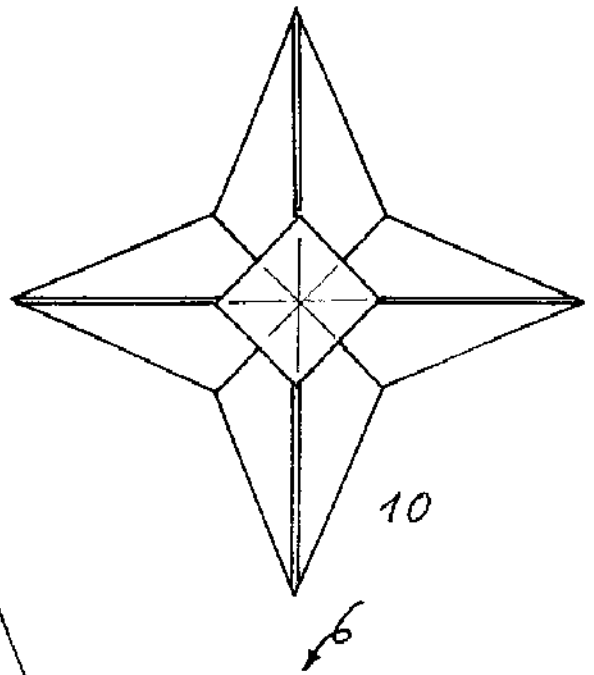
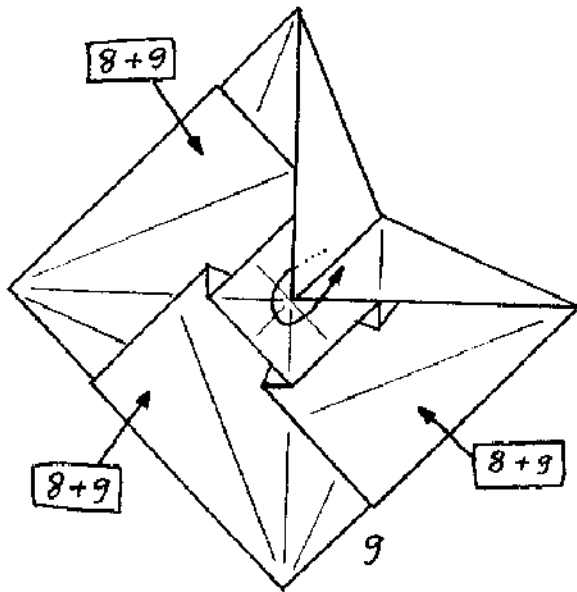

© Klaus-Dieter Ennen 9/99