

Stern Narsin:

(792)

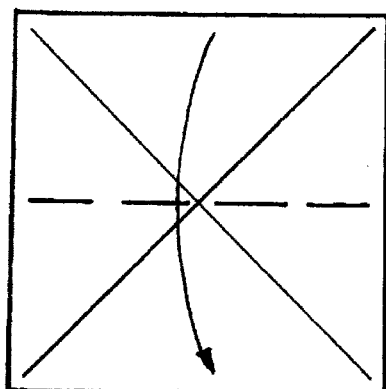

1

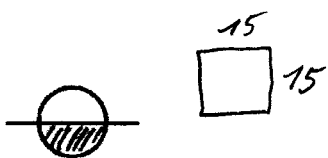
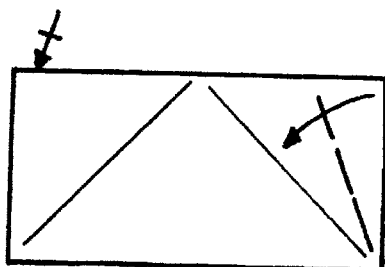

2

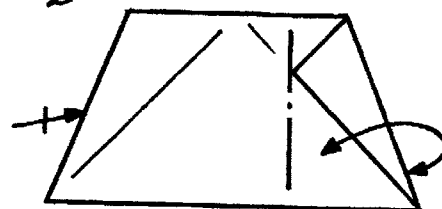

3

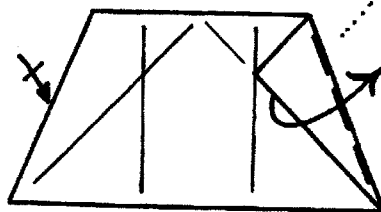

4

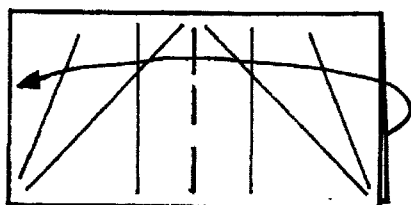

5

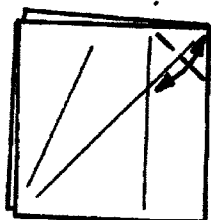

6

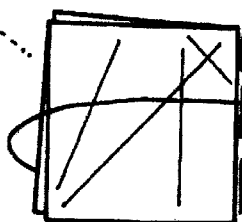

7

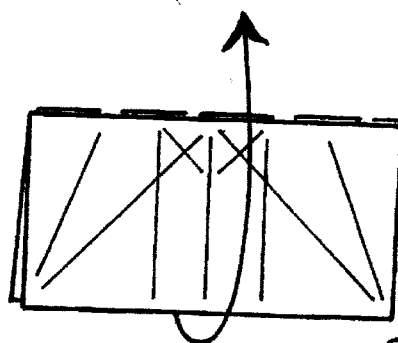

8

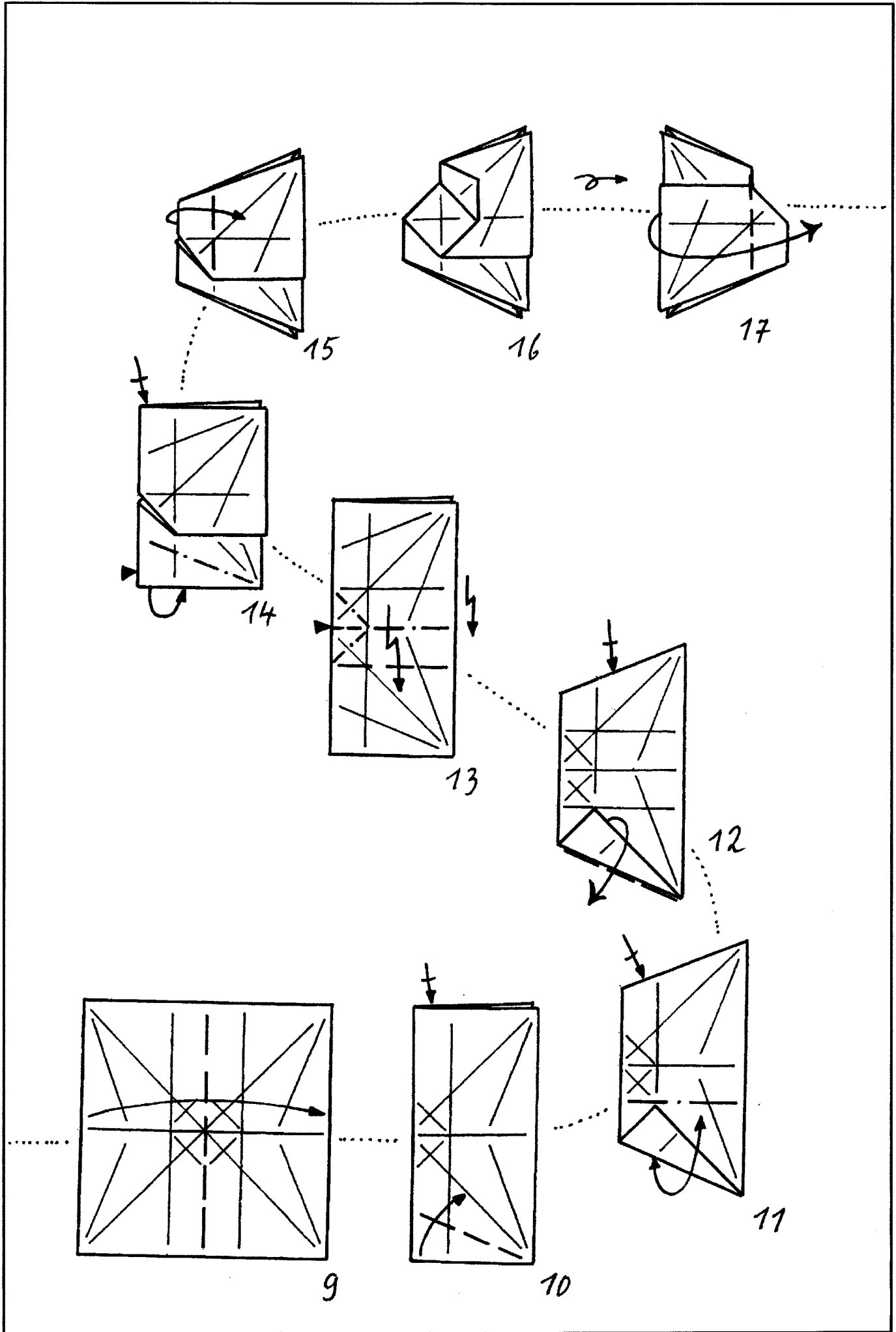

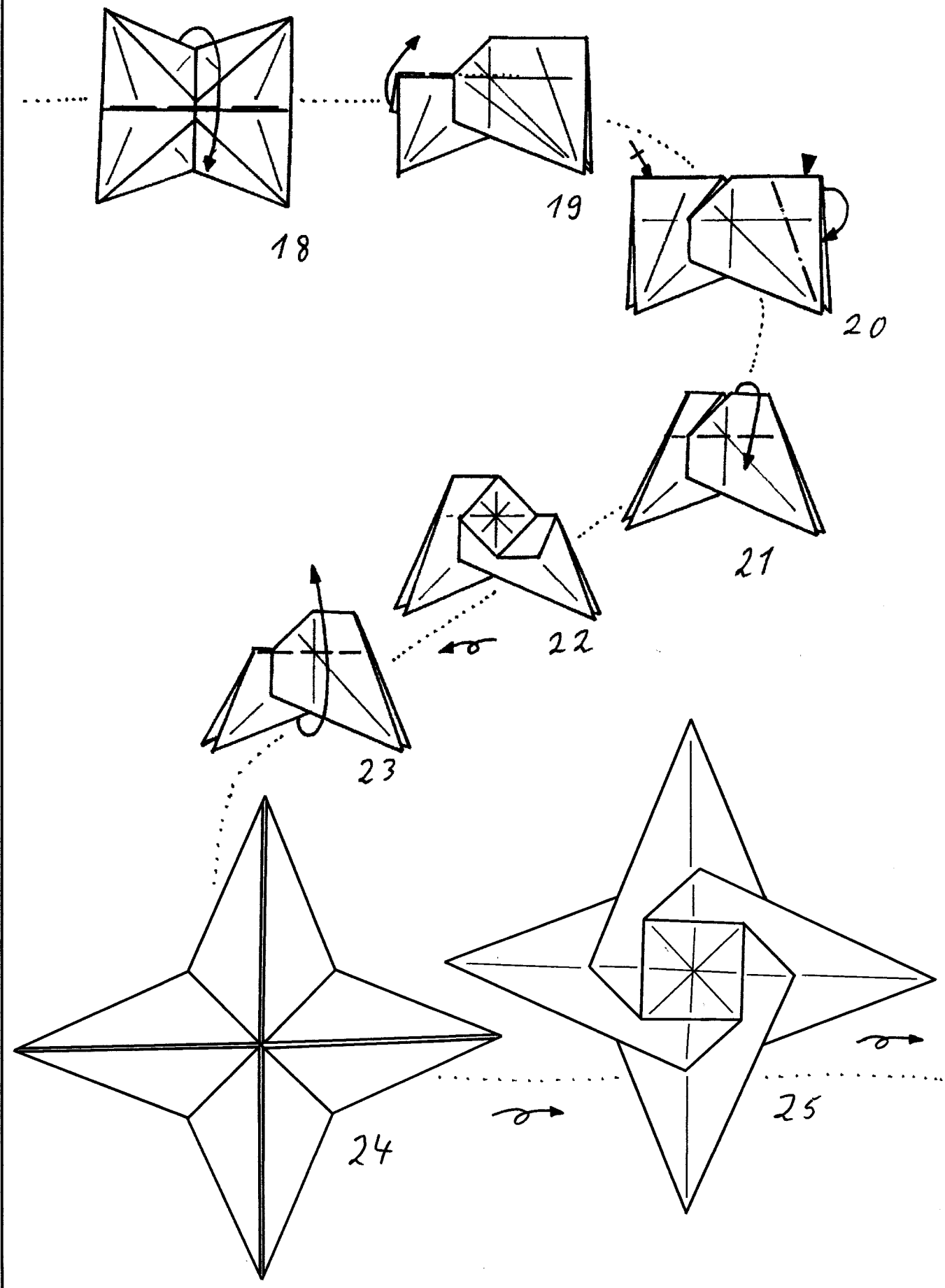

✂ Ausschneiden:

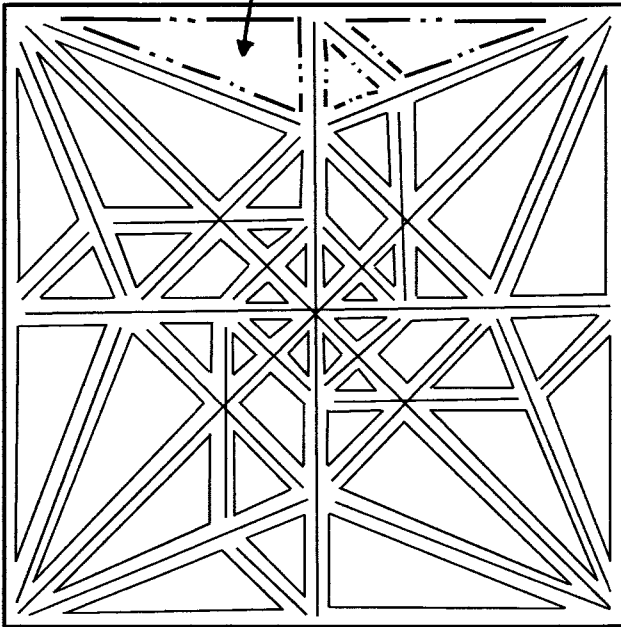

28

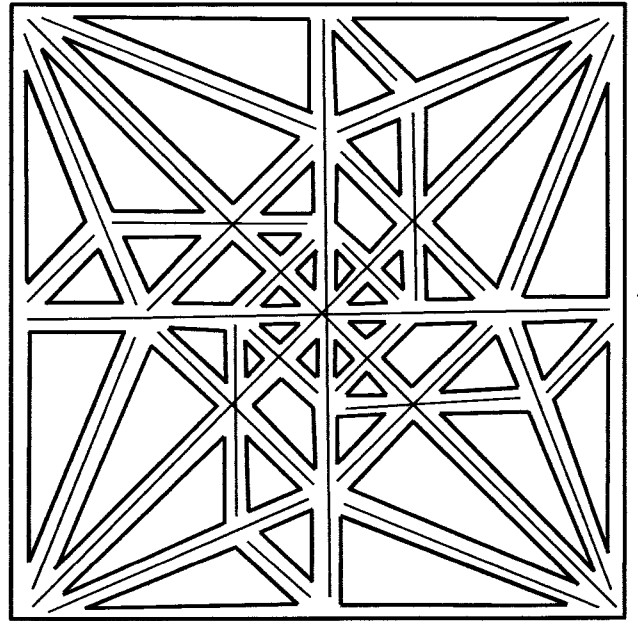

Wieder zusammen falten! 29

alle Flächen!

2,5 mm

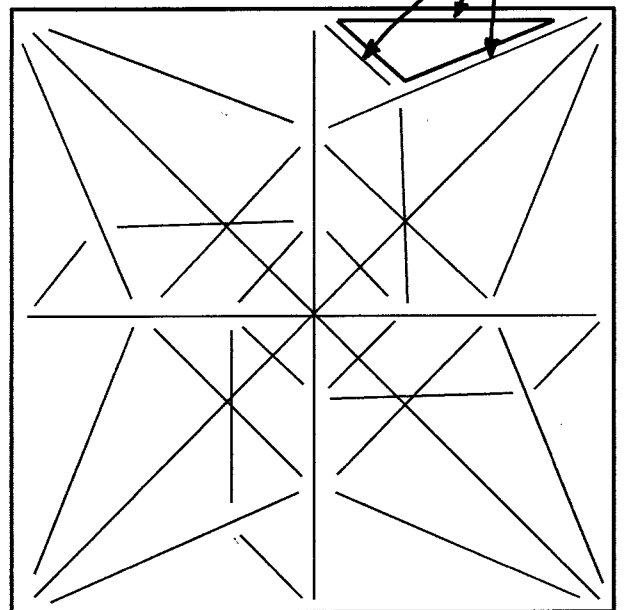

27

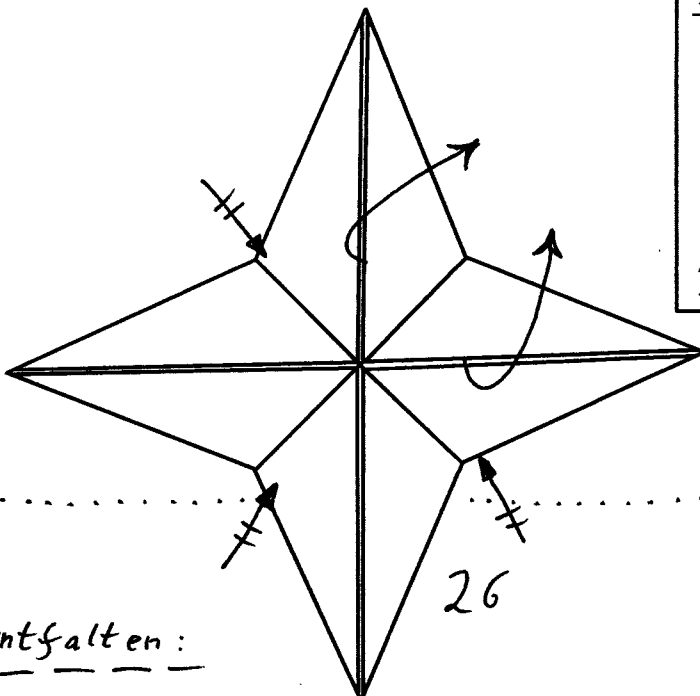

26

entfalten:

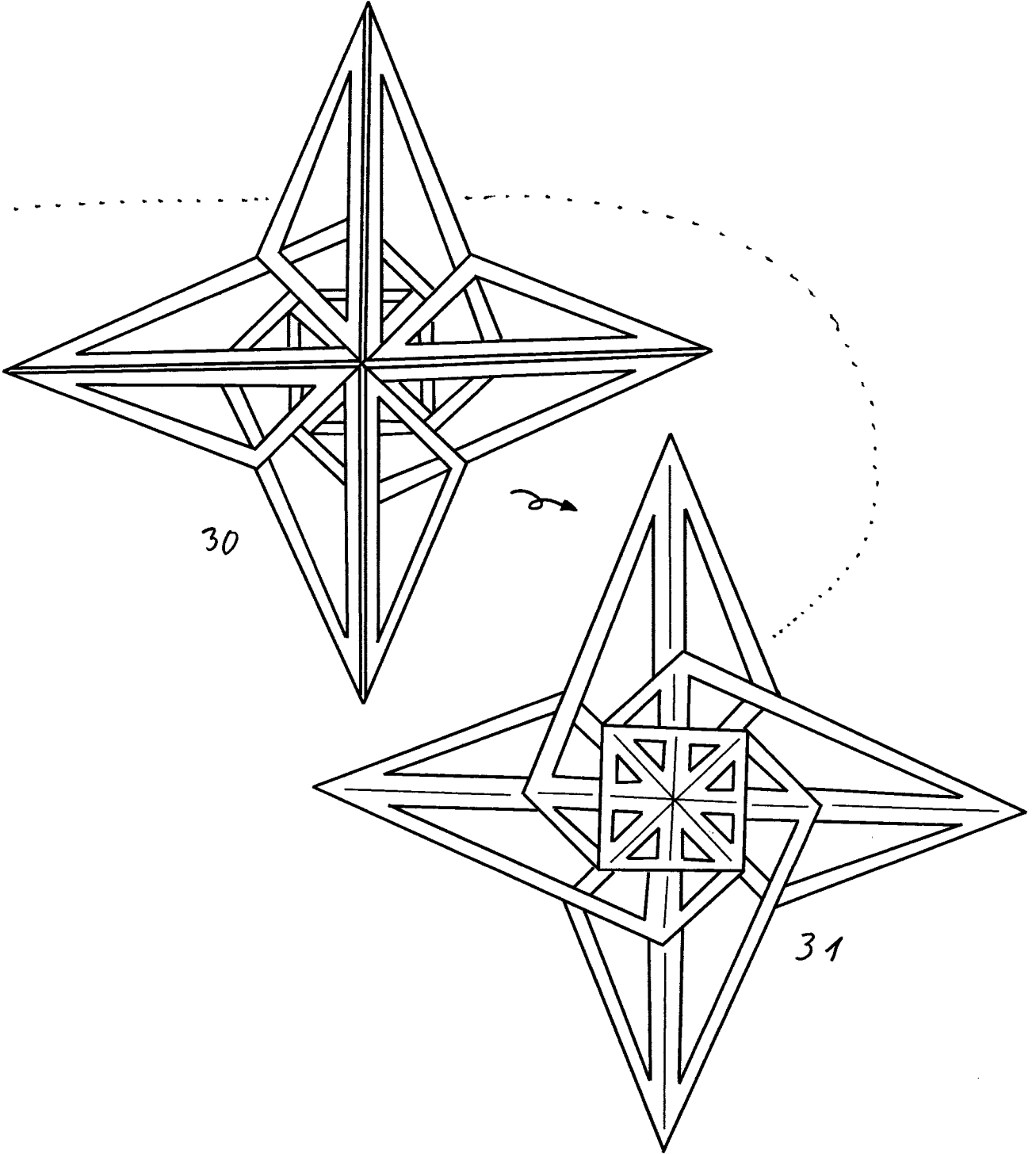

30

31

© Klaus-Dieter Ennen 2118